

Accepted Manuscript

OmniClimbers: Omni-directional magnetic wheeled climbing robots for inspection of ferromagnetic structures

Mahmoud Tavakoli, Carlos Viegas, Lino Marques, J. Norberto Pires, Aníbal T. de Almeida

PII: S0921-8890(13)00102-4

DOI: <http://dx.doi.org/10.1016/j.robot.2013.05.005>

Reference: ROBOT 2138

To appear in: *Robotics and Autonomous Systems*

Received date: 18 December 2012

Revised date: 16 May 2013

Accepted date: 24 May 2013

Please cite this article as: M. Tavakoli, C. Viegas, L. Marques, J. Norberto Pires, A.T. de Almeida, OmniClimbers: Omni-directional magnetic wheeled climbing robots for inspection of ferromagnetic structures, *Robotics and Autonomous Systems* (2013), <http://dx.doi.org/10.1016/j.robot.2013.05.005>

This is a PDF file of an unedited manuscript that has been accepted for publication. As a service to our customers we are providing this early version of the manuscript. The manuscript will undergo copyediting, typesetting, and review of the resulting proof before it is published in its final form. Please note that during the production process errors may be discovered which could affect the content, and all legal disclaimers that apply to the journal pertain.

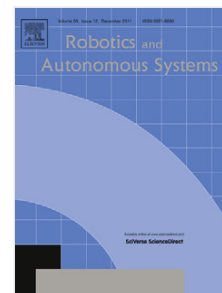

OmniClimbers: omni-directional magnetic wheeled climbing robots for inspection of ferromagnetic structures

Mahmoud Tavakoli¹, Carlos Viegas¹, Lino Marques¹, J. Norberto Pires² and Aníbal T. de Almeida¹

Abstract— This paper introduces **Omniclimber**, a new climbing robot with high maneuverability for inspection of ferromagnetic **flat and convex** human made structures. In addition to maneuverability, adaptability to various structures with different curvatures and materials are addressed. The conceptual and detailed design of **Omniclimbers** are presented and two prototypes of the robot are introduced. Several laboratory and field tests are reported, and the results are discussed.

I. INTRODUCTION

Climbing robots have been developed during the past two decades in order to facilitate some jobs such as periodical inspections for detection of cracks, corrosion, material degradation and weldings defects on tanks and piping. Other applications of interest include ship hull grooming, cleaning and painting of such structures.

For climbing a surface, design of the locomotion mechanism and the surface adherence mechanism are the main challenges. For holding a robot attached to a smooth surface, the mainly used systems are: suction cups [1], [2], [3], [4], attraction force generated by propeller (negative pressure) [5], [6] or magnets [7], [8], [9], [10]. Other new systems such as biological inspired adherence through wet or dry adhesion and electro adherence have also been developed (See [11] for instance). Robots whose end-effectors match engineered features of the environment like fences or porous materials, pipes or bars [12], [13], [14], [15] were also developed. Gas and oil tanks, wind turbines, pipelines and marine vessels are examples of the structures which are target of this research work. Such structures share three common aspects:

- They need periodical inspection, maintenance or cleaning
- Their exterior circumference is convex
- Most of them are built from ferromagnetic material

As the desired structures for this project are ferromagnetic, and not always flat, usage of negative pressure is not the best choice due to energy consumption and curvature adaptability problems and magnetic adherence is a more appropriate choice. Some of the applications e.g. painting or cleaning or periodical inspection of the whole structure need the robot scan the whole structure. Some other applications needs the robot to reach to a pose on the structure rapidly and then perform in situ maintenance (welding, changing of parts, etc.). In both cases high navigation velocity and good maneuverability are desirable.

¹Institute for Systems and Robotics, Dep. of Electrical and Computer Eng., University of Coimbra, Portugal. {mahmoud, carlosviegas, lino, adealmeida}@isr.uc.pt²Dep. of Mechanical Eng., University of Coimbra norberto@dem.uc.pt

Pole climbing robots received an increasing attention during the previous years due to their application in inspection of pipelines and similar structures. After some advances on the mechanical structure, recently other aspects of such robots, e.g. self calibration [16] and mapping of the structures [17], [18], [19] are being investigated. But yet high maneuverability is an important objective which should be addressed. For instance one of the limitations of many pole climbing robots is that they can not rotate around the pole [20], [21], [22], [23], or in order to rotate around the pole, they have high energy and time costs [24], [25], [26], [27].

The main objectives of this research is to implement a robot which is able to climb and navigate over ferromagnetic structures considering:

- High maneuverability.
- High speed.
- Adaptability to a reasonable range of curvature.
- Adaptability to a reasonable range of structure's material and thickness
- Simplicity.

Recently a couple of wheel based magnetic climbing robots have been developed. Magnebike [28] is a successful implementation of an inspection robot for ferromagnetic structures. It weights 3.5kg and can climb with a max. speed of $2.7 \frac{m}{sec}$. Another example of a wheel based magnetic climbing robot can be seen in [29], a two DOF simple climbing robot for flat ferromagnetic surfaces.

Climbing robots with magnetic tracks have also been developed [30], [31]. Because of their large track systems, these robots offer good stability on vertical surfaces, but they offer less maneuverability and adaptability in curved structures compared to the wheeled robots. For a better maneuverability on vertical surfaces, D. Schmidt et al. have developed an omni-directional climbing robot with negative pressure adhesion mechanism. The robot integrates 3 wheels, each of them with 2 actuators for driving and steering [32]. While using active driving and steering on each wheel offers a better control over the robot's trajectory, it also increases the system complexity. Oliveira et al. developed a wheeled based magnetic climbing robot with dynamic distance adjustment from the surface [33]. The robot includes 4 driving motors and 4 motors for changing the distance of the magnets from the structure. This architecture offers a good control over the magnetic force, however it increases the robot's weight and complexity. Yet there is a lot of space for improvements on many aspects of magnetic wheel based climbing robots. In the current research we tried to

concentrate on maneuverability, adaptability and simplicity to various structures. By using omni-directional wheels, we implemented a simple robot with minimum possible DOFs which offers omnidirectional movements. Furthermore we integrated a novel mechanism in the robot's chassis which allows the robot adapt to the curved surfaces without actuation.

In this paper, we describe the conceptual design of omniclembers and its novelties. We demonstrate the development and testing over two prototypes of the omniclember. The first prototype of the robot was already demonstrated in [34]. The second prototype is an evolution of the first one, resolving some of the main problems of its predecessor.

II. OMNICLIMBER'S MAIN NOVELTIES

In the conceptual design of the Omniclember robot we tried to address two main problems: Maneuverability on the structure and adaptability to different structures. The current design involves the following main novelties:

- 1) **Flexible chassis for a better adaptability to the curvature:** Utilizing novel chassis solutions with a passive bending system we enable the robot to self-adapt to a big range of curvatures, with a passive mechanism.
- 2) **Omni-directional wheels for superior maneuverability:** Omni wheels have been widely used on mobile robots. The main reason of their popularity is the high maneuverability they offer to the mobile robots. Utilizing 3 omni-directional wheels placed at 120° will enable the robot to move on (x,y) direction and rotate around its central axis.
- 3) **adjustability:** To increase the adaptability to various structures we considered adjustability of the mechanisms in all design aspects. This will be further described in section III-E.

III. DESIGN AND DEVELOPMENT

A. Chassis and curvature adapting system

A schematic of the passive curvature adaptation system is shown in figure 1.

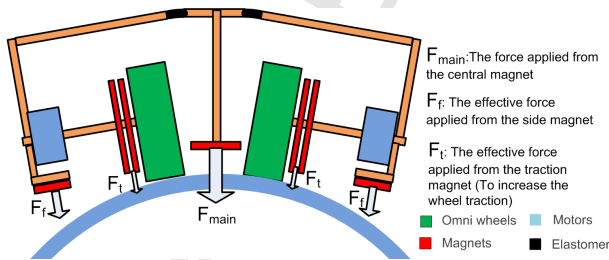

Fig. 1. Schematic of the curvature adapting system.

The central magnet, is the strongest magnet which should provide enough normal force in order to hold the mechanism

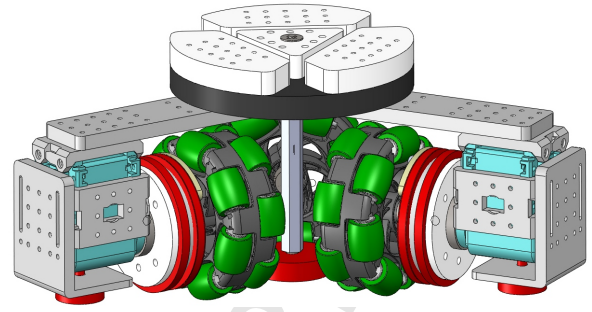

Fig. 2. First version of the omniclember used an elastomer with ABS reinforcement as the chassis.

attached to the surface. Three side magnets (two of them shown in the schematic), play the main role for the curvature adapting system. They should apply the necessary force in order to bend the chassis. F_f is the effective force applied from the structure to the side magnets. This applied force also increases wheel traction of the robot. Note that for flat surfaces there is no need for side magnets as the chassis does not need to bend. In this case, and provided that the structure's material and thickness are good enough to guarantee the necessary traction force through the magnetic traction system alone, side magnets can be removed. Magnets which are installed near or on the wheels are part of the magnetic traction system. Their role is to provide enough wheel traction to allow the robot to climb any structure without slippage. They also provide additional force to bend the robot arms and adapt to the curvature. Geometrical studies were made in order to see how the robot would adapt to structures with different radius. This analysis allowed to determine the bending angle of the robot arms for each structure and the distance of the side magnets to the structure. The maximum required bending angle of the robot arms for a curved structure with a diameter of 300 mm was 28° . The first version of the chassis used an elastomer disk and ABS reinforcements (figure 2).

However, this chassis caused some problems during the robot action. The elastomer used in the chassis suffered from torsion around its axis due to reaction forces from the wheels. Such torsion impaired the robot's climbing during the initial tests, due to lack of stability. Moreover due to such torsion, the robot could not precisely follow the desired trajectory. To solve this problem we developed a new rigid chassis which is only flexible around three joints (figure 3). This new chassis allows only a deflection around the axes which push the wheels against the structure. It also integrated torsional springs in the passive joints (figure 4) to bend the chassis and push the wheels toward the structure, thus reducing the required magnetic force. This new chassis also allowed the robot to tackle curved structures with smaller radius, as can be seen in the results.

B. Magnetic attraction force and central magnet unit

The main magnetic unit should hold the robot attached to the structure. This implies two conditions (figure 5).

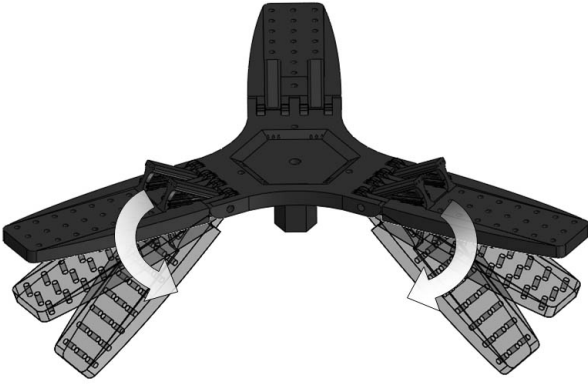

Fig. 3. The new chassis can only bend around the necessary axes.

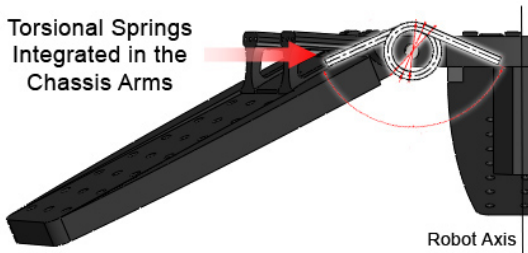

Fig. 4. Integrated Springs in each of the Omniclimber arms.

- 1) The magnet attraction force should apply enough normal force, so that the robot stays attached to the structure when moving on the structure. Therefore the product of the sliding friction coefficient between rubber and steel (wheel and structure) and the normal force should be greater than the robot's weight.
- 2) To keep all three wheels attached to the structure and avoid rotation around any of the contact points, the sum of the moments about each contact point should be zero.

Considering the robot's weight (1200 gr), and the center of the mass (figure 5), the first condition leads to a minimum normal force of 24N and the second condition leads to a minimum normal force of 13.9N. The attraction force between a permanent magnet and a ferromagnetic material depends on many factors. Among them are the area of the surface, magnetic flux, permeability of the structure material and distance between the structure and the permanent magnet. To calculate the attraction force from a distance, one should estimate the magnetic flux at the application point. Some permanent magnet manufacturers introduced an equation for estimating the attraction force at certain distance based on the attraction force on zero distance. For instance according to the HKCM website[35]:

$$F_r = \frac{F_h}{1 + s^3} \quad (1)$$

Where F_r is the attraction force at the distance of s , and F_h is the attraction force at the distance of zero. This

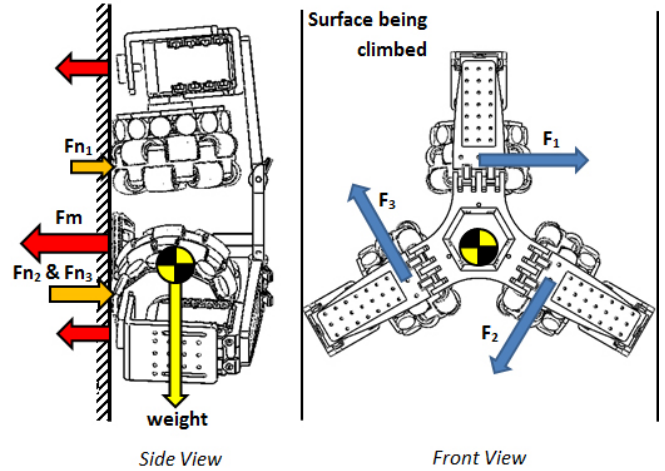

Fig. 5. Force diagram of the Omniclimber.

equation provides an estimate and not a precise value, but it can be used for the selection of appropriate magnets. In the website of the manufacturer [35], the attraction force of each permanent magnet at zero distance and for different type of materials are also presented. Using this equation and regarding the values of magnet attraction at zero distance from the manufacturer, and the distances of the magnets from the structure determined in the geometrical analysis, we selected the permanent magnets for the wheel traction and also the side magnets which can apply necessary force with a safety factor of 5. The central magnet role is to support the whole weight of the robot so it should be able to apply a force greater than 24 N. From the manufacturer website [35], we selected a magnet which can apply the necessary normal force at zero distance, considering a safety factor of 5 (120 N). The reason for such a big safety factor is that the values of the magnetic attraction in the manufacturer website is the maximum attraction force based on st37 material (A type of steel with high ferromagnetic property) and assuming maximum magnetic flux (meaning that the structure is thick enough to absorb the whole magnetic flux), while in practice neither the material nor the thickness of the structure are fix. On the other hand, we can adjust the distance of the magnet and the structure. Therefore if the normal force is excessive, one can increase the distance between the central magnet and the structure, when it is possible. During our experiments with the first prototype, we observed that keeping a distance between the central magnet and the structure lead to robot instability in most cases. On the other hand, if the central magnet contacts the structure, it leads to excessive normal force and thus excessive friction against the climbing movement. In such situation, reducing the friction coefficient could address the problem. We integrated a novel solution which changes the static friction coefficient between the central magnet and the structure to kinetic friction coefficient ($\mu_{static_{steel/steel}} = 0.74$ vs $\mu_{kinetic_{steel/steel}} = 0.57$ [36]). This reduces the resistive force by 23% at the same magnetic normal force. To do

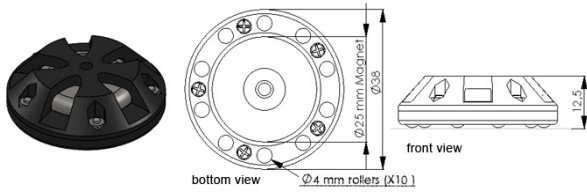

Fig. 6. Central magnet unit solution.

so, a solution was developed where the permanent magnet is surrounded by several steel balls of 4mm in diameter. These balls contact the surface and can roll in their hole, providing low friction contact (kinetic friction rather than static friction), while keeping the permanent magnet at a low distance (0.5 mm) from the structure (figure 6).

C. OmniWheels and magnetic traction system

The first prototype had two rings of magnets near the omniwheels to increase the traction to the wheels (shown by red rings near the wheels in figure 2). However, preliminary tests concluded that this system could not provide enough traction to the wheels on thin structures, and did not provide adjustability option to the magnetic force. In order to address this problem, we developed a new system with adjustable magnetic force that could adapt to a higher range of structure's material/thickness. An array of several magnets

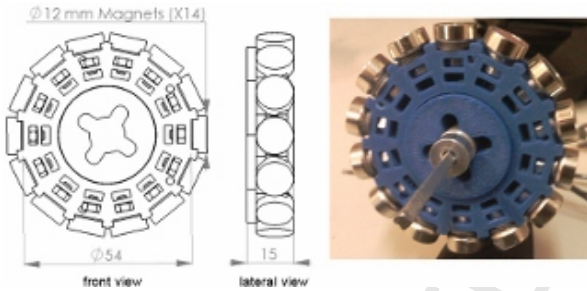

Fig. 7. Solution for the magnetic traction for the robot wheel.

was the adopted solution (figure 7). To select the number of magnets on array, we analyzed the magnetic force of the wheel with 6 to 16 magnets, comparing dimensions, weight, magnetic force and prototyping limitations (figure 11). The average magnetic force for each solution was determined, considering the influence of the number of magnets, the tilt of each magnet on the wheel (α) and its distance to the surface (d), illustrated on the figure 8. With the knowledge of the magnet's distance to surface and tilt (figure 9) and using the previous equation (1) for estimating the magnetic force at certain distance, also considering tilt influence (figure 10), we were able to calculate the attraction force for each array. The best compromise was achieved with the wheel with array of 14 cylindrical magnets with 12mm in diameter and adjustable distance to surface (figure 7 and 11 and table I). The wheels with 6, 8, 10 and 12 magnets provided a low minimum attraction force, so were discarded. As can be seen in figure 12, for lower number of magnets, e.g. 6

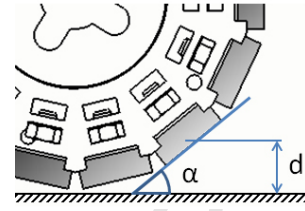

Fig. 8. For each wheel with an array of magnets from 6 to 16, we calculated the magnetic force for the closest magnets to the surface, taking into account its distance and angle.

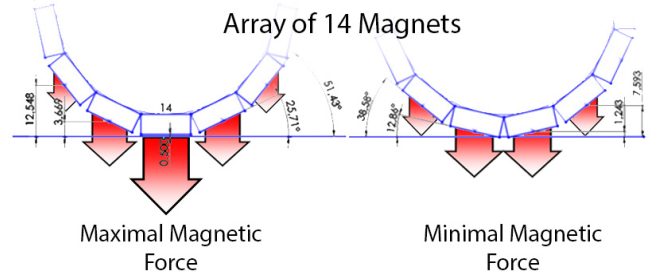

Fig. 9. Wheel positions with maximal and minimal magnetic force for the solution with an array of 14 magnets. The maximum magnetic attraction force occurs when one of the magnets is parallel to the surface and minimum attraction force occurs when all magnets are tilted relatively to the surface.

magnets, the maximum magnetic force (19.19 N) is almost 100 times bigger than the minimum magnetic force (0.20 N). In a solution with 14 magnets this ratio is as low as 2. The 16 magnets wheel proved to be impractical to be prototyped due to size restrictions. This new design also allows the adjustment of the magnetic force throughout the variation of the distance of the magnets to the surface (figure 12).

D. Control

A CM-510 robotis controller [37] is connected to all three actuators through a TTL network. The inverse kinematics of the omni-directional robot is loaded to the controller. CM-510 is equipped with an infrared receiver. At the current status the robot is controlled with a joystick which sends

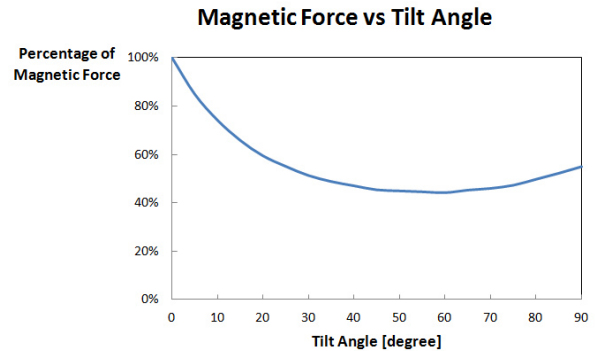

Fig. 10. Influence of the tilt of the magnet on the magnetic force to a fixed ferromagnetic structure, determined by magnetic field simulation software. The force increase after 45° is due to summation of attraction force from two sides of the permanent magnet, i.e. the front side + lateral side

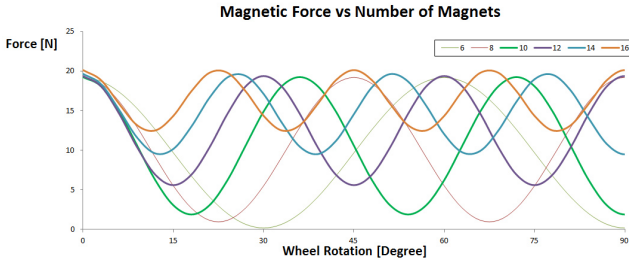

Fig. 11. Magnetic Force Analytically determined for each solution, for 90° degree rotation of the wheel.

Number of Magnets	6	8	10	12	14	16
Wheel weight [g]	156	166	176	186	196	206
Min Force [N]	0.20	0.97	1.90	5.61	9.50	12.43
Max Force [N]	19.19	19.20	19.26	19.39	19.66	20.13
Average Force [N]	9.69	10.08	10.58	12.50	14.58	16.28
Relative Mag Force	1.00	1.04	1.09	1.29	1.50	1.68

TABLE I

PERFORMANCE TABLE FOR EACH SOLUTION, REGARDING 90° DEGREES OF WHEEL ROTATION.

the high level motion commands (speed, forward, backward, right, left, rotate CW, rotate CCW) to the controller and CM-510 performs the velocity control on all actuators. A 12V input voltage, necessary to drive the controller and motors is provided to the robot either by an AC-DC adapter or by a 1000mAh Lithium-Polymer battery.

E. Adjustability

To maximize the adaptability of the robot to different structures, we considered adjustability of the system in various aspects of the design. Such adjustments should be performed before the inspection mission according to the structure's material, thickness and curvature. Figure 13 shows the possible adjustments of the robot:

- **Wheels location:** The radius of the wheels placement can be adjusted in order to maximize the adaptability to the climbing surface curvature. While a bigger radius for wheel placement guarantees a better stability of the robot on the structure due to a better tolerance to external forces (e.g. wind), for structures with bigger

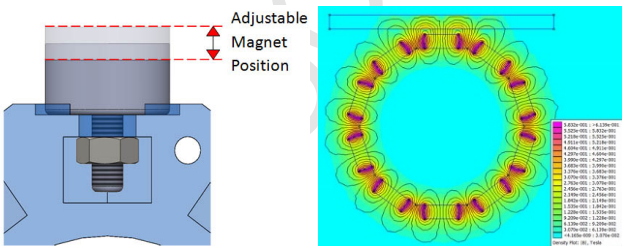

Fig. 12. On the left: Adjustable Magnet Positioning System. On the right: 2D Magnetic Flux Field Representation.

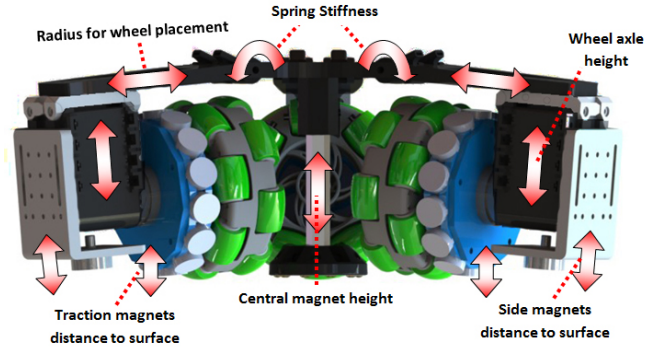

Fig. 13. Possible adjustments on OmniClimber.

curvature, a smaller radius results in a better adaptability to the structure.

- **Chassis stiffness:** Stiffness of the chassis against deflection on all axes and also against the torsion can be adjusted with different torsion springs. A stiffer chassis results in a more precise navigation. Omniclimber in its current status uses kinematics control for navigation. Deflection of the chassis results in change of the wheel placement, which is not currently being compensated in the kinematics control loop of the Omniclimber. This results in deviations from the desired path. Therefore the chassis should be as stiff as possible for the structure.
- **The distance between magnets and structure:** The structures are made of different materials and their thickness is also different. Both of these characters change the magnetic adhesion force between the robot and the structure which results in low adhesion or excessive friction between the wheels and the structure. For the best performance a balance between the attraction force of the magnets and friction, when in contact with surface, should be established. Wheel magnets distance to surface can be adjusted in order to achieve that optimal performance balance for a specific structure (figure 12). Also the distance of the side magnets to the surface can be adjusted to guarantee enough deflection of the chassis for each type of structure and curved surface radius.

F. Prototypes

Figure 14 shows the first prototype of the robot and figure 15 shows the second prototype. Three AX-12 DC motors were used as the actuators. AX-12 Dynamixel actuators [37] combine a DC motor, gearbox and driver and can be controlled through a TTL network. They can deliver up to 1.2 N.m and weight 72 g . Most of the parts were custom designed and 3D printed. The total weight of the robot without batteries is 1099 g . The characteristics of the two prototypes are shown in table II.

IV. TESTS AND RESULTS

Omniclimber was tested on several structures. First version of Omniclimber was tested on a wind turbine foundation

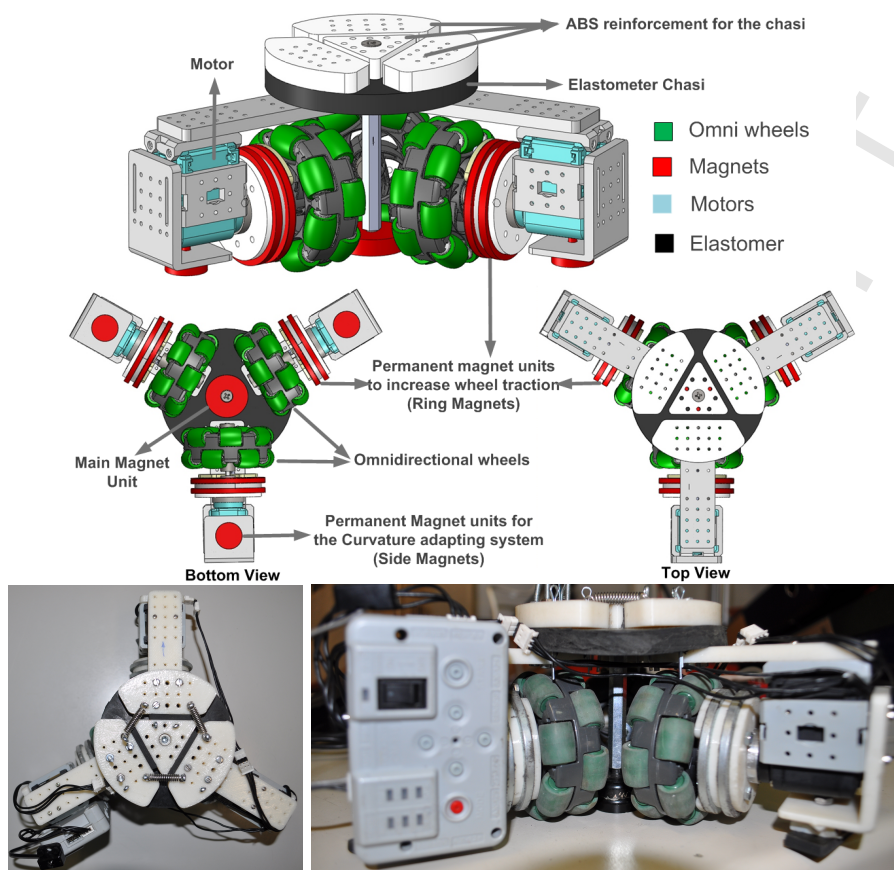

Fig. 14. First prototype of the Omniclimber robot.

shown in figure 17. These tests proved the feasibility of the concept but revealed some of the main problems. Problems concerning chassis deflection or excessive friction between the magnets and the surface impaired the robot climbing. This resulted in the development of new systems, particularly the chassis, traction system and central magnet, as described before. After the modifications, more tests were conducted, a laboratory experiment on a flat surface of a locker which is shown in figure 19 and two field tests, on a structure with a radius of 150 mm, shown in figure 20 (The shown structure is a propane gas bottle), and on a large steel horizontal structure with a radius of 1050 mm, demonstrated in figure 18 (the shown structure is a chimney for exhaust fumes from combustion). Omniclimber could climb and navigate on all structures successfully. Therefore the minimum structure radius which omniclimber could overcome was reduced to 150 mm, since the first prototype was not able to climb the propane gas bottle. Taking advantage of the omni-directional system and AX-12 actuator with relatively high output speed (59 rpm at no load), the robot could turn around its axis, or move toward any direction agilely (max. climbing speed 11cm/sec). The robot could adapt itself to all curved structures, as expected. The magnetic attraction force changes abruptly on different structures. This is due to the structure material

and thickness. To overcome this problem the Omniclimber prototype has a multitude of adjustable systems to adjust (manually) the attraction force according to each situation. For the navigation on the locker with a steel sheet thickness of 1 mm, the side magnets had to be fitted to the prototype, in order to increase the traction on the wheels. Also, on the propane bottle, side magnets were used to help the chassis bend and adapt the structure. On the horizontal chimney the steel was thicker (3 mm), which allowed to run the robot without side magnets. But the main problem we encountered was due to the occasional contact between the traction magnets and the surface of the structure. This is due to the small distance between the traction magnets and the climbing structure which is not fixed for different structure diameters and also due to the flexibility of the chassis which causes such occasional contact. A new design of the traction system which guarantees a contact-less interaction between the wheel and the structure is under development.

The robot should be able to carry some tools in order to perform inspection operations. The payload of the robot depends on the structure material and thinness, since the normal magnetic adhesion force changes with these parameters. We tested the robots on a structure with a thickness of 3 mm. The payload for the first and second prototypes were 82(g) and 370(g) relatively. In both cases a

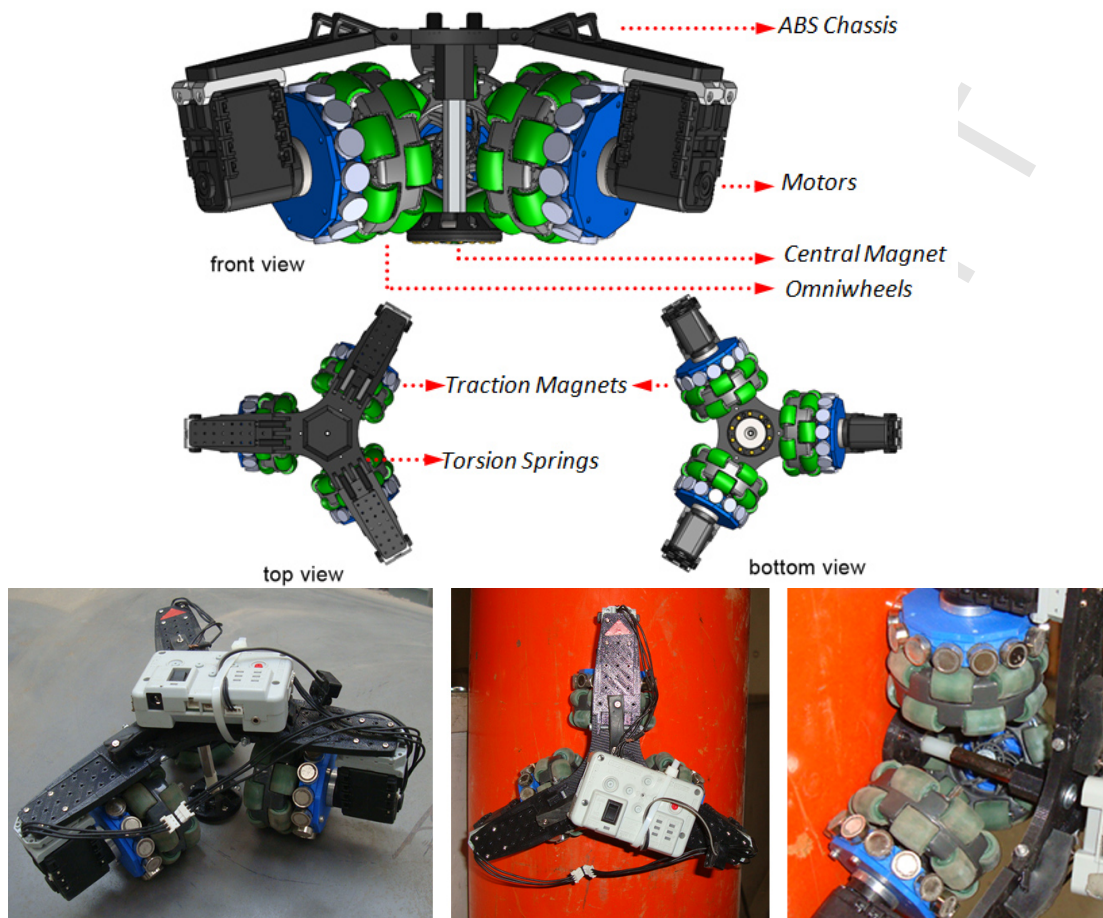

Fig. 15. Second prototype of the Omniclimber robot. The chassis design, the central magnet and wheel traction magnets are evolved to address some of the problems associated with the first prototype.

1Ah battery and the controller which weight 142g together are already installed on the robot. Therefore the second prototype is able to carry several tools, e.g. a camera, or an ultrasonic probe.

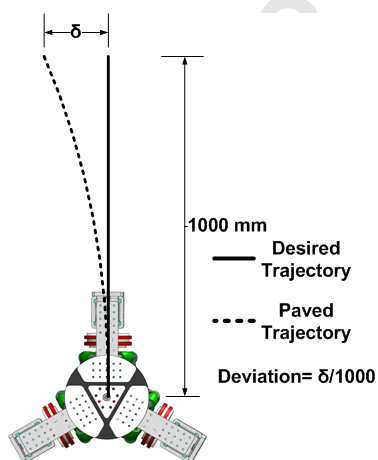

Fig. 16. The deviation from the robot's desired trajectory was measured by performing tests on a straight path of 1000 mm

To determine the robot's accuracy on following a straight trajectory, we evaluated this feature for both prototypes on a vertical and a horizontal trajectory, and measured the deviation from the desired trajectory in 1000 mm of distance. The deviation is measured on the axis perpendicular to the desired axis as can be seen in figure 16. Based on 10 experiments, the first prototype showed an average deviation of 6%, in the vertical axis, while the second prototype showed better results with an average error of 4%. We also tested a horizontal path of 1000 mm on the flat surface, and resulted in an average deviation of 7% for the first prototype and 5% for the second prototype. While for a vertical movement, gravity force acts symmetrically for both wheels, in the horizontal movement, gravity causes a lower traction on the higher wheels, which causes a bigger deviation compared to the vertical movement. Since the test surface is very thin ($\approx 1\text{mm}$), higher magnetic forces on the second prototype wheel helps for better wheel traction and less error. While the first prototype is not able to navigate on the 300mm propane bottle, the second prototype acts even better on this structure compared to the flat surface (probably due to its higher adhesion forces), with an average deviation of 2% on the vertical axis. Since deviation occurs due to the

Item	OmniClimber I	OmniClimber II
Dimensions	$\phi 250mm$, Height : $102mm$	$\phi 246mm$, Height : $90mm$
Weight without battery and controller	1099 g	804 g
Weight with battery and controller	1241 g	946 g
Maximum Climbing Speed	$11 \frac{cm}{sec}$	$11 \frac{cm}{sec}$
Actuation	3 AX-12 rotary actuators	3 AX-12 rotary actuators
Battery	Lithium Polymer 1000 mAh	Lithium Polymer 1000 mAh
Wheels	omni-directional	omni-directional
Controller	Robotis CM-510	Robotis CM-510
Operating Voltage	12 V	12 V
Communication	TTL	TTL

TABLE II

THE MAIN CHARACTERISTICS OF THE TWO VERSIONS OF THE OMNICLIMBER ROBOT.

different traction on the wheels, one can compensate that by estimation of the traction on the wheels from current (I) feedback, or by integration of an IMU or other exteroceptive sensors, in order to compensate for the deviation from the desired trajectory. But in order to purely evaluate the mechanical design, we do not apply any feedback control to compensate for loss of tracking on the wheels. Table III sums the results of the tests and conclusions drawn.



Fig. 19. A laboratory experiment on a flat surface of a locker. The omniclember could successfully navigate on the locker, which is made of a very thin steel sheet less than $1mm$.

- **Magnet arrangement:**

Using a 2D finite element software, FEMM (Finite Element Method Magnetics) 4.2., we were able to simulate magnetic fields and the force on various magnetic structures generated by an array of permanent magnets (shown in figure 12). Results obtained showed that a Halbach array provided 1.81 times more magnetic



Fig. 20. Omniclember tested on the 150mm radius propane bottle.

force than the adopted solution of same orientation of magnetic poles for all magnets. A Halbach array is a special arrangement of permanent magnets that augments the magnetic field on one side of the array while canceling the field to near zero on the other side. We then conducted a series of experiments with a setup of magnets arranged in an Halbach Array and same magnetic orientation. We obtained a real gain of 34 percent more magnetic force for the Halbach Array, with the same configuration tested in the software. Since the magnetic force already proved to be sufficient for most magnetic surfaces, we chose not to adopt the Halbach Array in this prototype. Further development on the robot could include this solution.

V. DISCUSSION AND FUTURE WORK

In this paper we presented Omniclember robot. This robot is able to climb ferromagnetic curved structures with diameter as low as 300 mm, up to flat structures, and with various thickness. This made Omniclember as a unique solution with high maneuverability which can adapt to a big range of structures. Omniclember includes several novelties, e.g. the central magnet unit, the adaptable chassis and the magnetic omni-directional wheels. One of the problems that we encountered during the tests was non-smooth movements of the robot. The robot suffered from horizontal and vertical vibrations which is due to noncontinuous contact nature of omni-directional wheels. Our current research mainly focuses on study and analysis of vibration on the robot due to application of omni-directional wheels. Future work include a new design of the omni-directional magnetic wheels with integrated magnets to avoid any contact with climbing surface, and improving the trajectory following accuracy through integration of exteroceptive sensors.

VI. ACKNOWLEDGMENT

This research work was partially supported by the Portuguese Foundation of Science and Technology,

Structure	Curvature radius	Metal thickness (mm)	Side magnets	1 st prot. navigation	2 nd prot. navigation	Notes
Locker	Flat	$t < 1$	Fitted	***	***	Sidemagnets added to increase the normal force
Propane Bottle	150 mm	$2 < t < 3$	Fitted	Not able	***	Sidemagnets helped adapting the structure. 1 st prototype could not climb this structure
Wind turbine foundation	600 mm	$t > 3$	Fitted	**	***	High magnetic force and thus high friction
Horizontal chimney	1050 mm	$t > 3$	Not fitted	*	**	The fact that the structure was horizontal helped the performance.

TABLE III

RESULTS OF THE TESTS PERFORMED ON THE VARIOUS STRUCTURES. NAVIGATION PERFORMANCE WAS CATEGORIZED ACCORDING TO THE SUCCESS RATE FOR 10 TESTS PERFORMED ON EACH STRUCTURE. * SEVERAL DETACHMENTS FROM THE STRUCTURE. ** OCCASIONAL DETACHMENT FROM THE STRUCTURE *** GOOD ADAPTATION TO, AND NAVIGATION ON THE STRUCTURE **** VIBRATION FREE AND SMOOTH NAVIGATION ON THE STRUCTURE

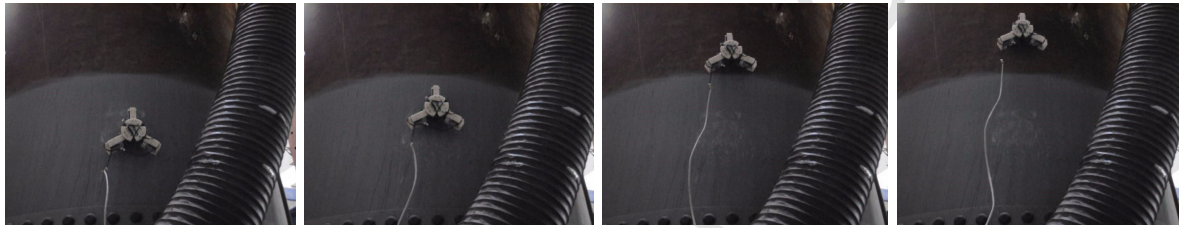

Fig. 17. Field test of the first prototype on an wind turbine foundation with a radius of 60cm. The robot could adapt to the structure after some adjustments on the central magnet.// * Several detachments from the structure. ** Occasional detachment from the structure *** Good adaptation to the structure and navigation on the structure **** vibration free and smooth navigation on the structure

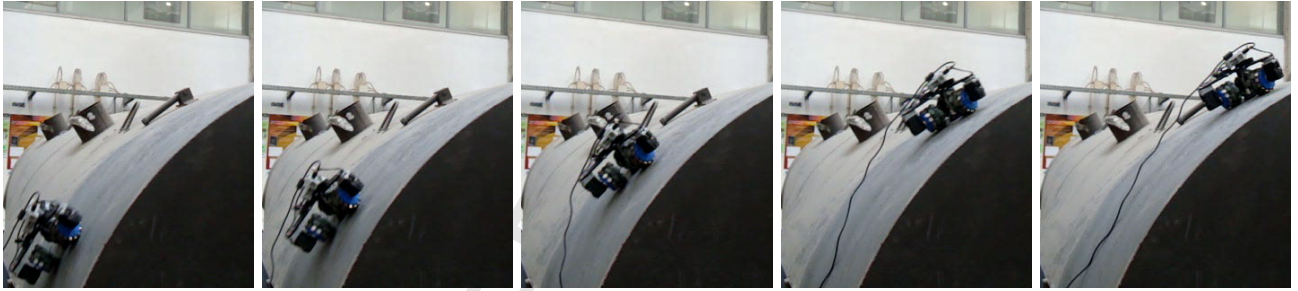

Fig. 18. Omniclimber tested on the horizontal curved structure, with 1050mm in radius.

contract SFRH/BPD/70557/2010 and PTDC/EME-CRO/121547/2010.

REFERENCES

- [1] H. Dulimarta and R. L. Tummala, "Design and control of miniature climbing robots with nonholonomic constraints," in *World Congress on Intelligent Control and Automation*, Shanghai, P.R.China, June 2002.
- [2] L. S. W. Yan, X. Dianguo, Z. Yanzheng, S. Haoand, and G. Xuesban, "Development and application of wall-climbing robots," in *Proc. IEEE Int. Conf. on Robotics and Automation*, Detroit, USA, May 1999, pp. 1207–1212.
- [3] D. Longo and G. Muscato, "A modular approach for the design of the alicia climbing robot for industrial inspection," *Industrial Robot: An International Journal*, vol. 31, no. 2, pp. 148–158, 2004.
- [4] G. La Rosa, M. Messina, G. Muscato, and R. Sinatra, "A low-cost lightweight climbing robot for the inspection of vertical surfaces," *Mechatronics*, vol. 12, no. 1, pp. 71–96, 2002.
- [5] A. Nishi, "A wall climbing robot using propulsive force of propeller," in *Proc. IEEE Int. Conf. on Advanced Robotics, ICAR*, 1991, pp. 320–325.
- [6] J. Xiao, W. Morris, N. Chakravarthy, and A. Calle, "City climber: a new generation of mobile robot with wall-climbing capability," in *Proceedings of SPIE*, vol. 6230, no. 1, 2006.
- [7] J. C. Grieco, M. Prieto, M. Armada, and P. G. de Santos, "A six-legged climbing robot for high payloads," in *IEEE Int. Conf. on Cont. App.*, Trieste, Italy, Sept. 1998, pp. 446–450.
- [8] S. Hirose, A. Nagabuko, and R. Toyama, "Machine that can walk and climb on floors, walls, and ceilings," in *Proc. IEEE Int. Conf. on Advanced Robotics*, Pisa, Italy, June 1991, pp. 753–758.
- [9] J. Berengueres, K. Tadakuma, T. Kamoi, and R. Kratz, "Compliant distributed magnetic adhesion device for wall climbing," in *IEEE International Conference on Robotics and Automation*. IEEE, 2007, pp. 1256–1261.
- [10] J. Grieco, M. Prieto, M. Armada, and P. Gonzalez de Santos, "A six-legged climbing robot for high payloads," in *Control Applications, 1998. Proceedings of the 1998 IEEE International Conference on*, vol. 1. IEEE, 1998, pp. 446–450.
- [11] D. Santos, B. Heyneman, S. Kim, N. Esparza, and M. Cutkosky, "Gecko-inspired climbing behaviors on vertical and overhanging surfaces," in *Robotics and Automation, 2008. ICRA 2008. IEEE International Conference on*. IEEE, 2008, pp. 1125–1131.
- [12] C. Balaguer, A. Giménez, J. Pastor, V. Padrón, and M. Abderrahim, "A climbing autonomous robot for inspection applications in 3D complex environments," *Robotica*, vol. 18, no. 03, pp. 287–297, 2000.
- [13] M. Almonacid, R. Saltaren, R. Aracil, and O. Reinoso, "Motion planning of a climbing parallel robot," *IEEE Transactions on Robotics and Automation*, vol. 19, no. 3, pp. 485–489, 2003.

- [14] M. Tavakoli, M. Zakerzadeh, G. Vossoughi, and S. Bagheri, "A hybrid pole climbing and manipulating robot with minimum DOFs for construction and service applications," *Journal of Industrial Robot*, vol. 32, no. 2, pp. 171–178, March 2005.
- [15] M. Tavakoli, L. Marques, and A. de Almeida, "3DCLIMBER: Climbing and manipulation over 3D structures," *Journal of Mechatronics*, vol. 21, no. 1, pp. 48–62, 2011.
- [16] —, "A low cost method for self calibration of pole climbing robots," *Robotica*, 2010.
- [17] F. Tache, F. Pomerleau, G. Caprari, R. Siegwart, M. Bosse, and R. Moser, "Three-dimensional localization for the MagneBike inspection robot," *Journal of Field Robotics*, vol. 34, no. 4, pp. 303–309, 2010.
- [18] M. Tavakoli, G. Cabrita, R. Faria, L. Marques, and A. de Almeida, "Cooperative multi-agent mapping of three-dimensional structures for pipeline inspection applications," *The International Journal of Robotics Research*, vol. 31, no. 12, pp. 1489–1503, 2012.
- [19] E. Stumm, A. Breitenmoser, F. Pomerleau, C. Pradalier, and R. Siegwart, "Tensor-voting-based navigation for robotic inspection of 3d surfaces using lidar point clouds," *The International Journal of Robotics Research*, vol. 31, no. 12, pp. 1465–1488, 2012.
- [20] G. C. Haynes, A. Khripin, G. Lynch, J. Amory, A. Saunders, A. A. Rizzi, and D. E. Koditschek, "Rapid pole climbing with a quadrupedal robot," in *Proceedings of the IEEE International Conference on Robotics and Automation*, 2009.
- [21] C. Balaguer, J. Pastor, A. Giménez, V. Padrón, and M. Abderrahim, "Roma: A multifunctional autonomous self-supported climbing robot for inspection application," in *3rd IFAC Symposium on Intelligent Autonomous Vehicles*, Madrid, Spain, 1998, pp. 357–362.
- [22] A. Sadeghi, H. Moradi, and M. N. Ahmadabadi, "Analysis, simulation, and implementation of a human-inspired pole climbing robot," *Robotica*, vol. 30, pp. 279–287.
- [23] A. Baghani, M. Ahmadabadi, and A. Harati, "Kinematics modelling of a wheel-based pole climbing robot (UT-PCR)," in *Proc. IEEE Int. Conf. on Robotics and Automation*, Barcelona, April 18–22 2005.
- [24] J. Sabater, R. Saltarén, R. Aracil, E. Yime, and J. Azorin, "Teleoperated parallel climbing robots in nuclear installations," *Industrial Robot: An International Journal*, vol. 33, no. 5, pp. 381–386, 2006.
- [25] J. Resino, A. Jardón, A. Gimenez, and C. Balaguer, "Analysis of the direct and inverse kinematics of roma 2 robot," *Proc. of the 8th International Conference on Climbing and Walking Robots*, pp. 869–874, 2006.
- [26] M. Tavakoli, M. Zakerzadeh, G. Vossoughi, and S. Bagheri, "Design and Prototyping of a Hybrid Pole Climbing and Manipulating Robot with Minimum DOFs for Construction and Service Applications," *Climbing and Walking Robots: Proceedings of the 7th International Conference Clawar 2004*, 2005.
- [27] M. Tavakoli, L. Marques, and A. de Almeida, "Development of an industrial pipeline inspection robot," *Industrial Robot: An International Journal*, vol. 37, no. 3, pp. 309–322, 2010.
- [28] F. Tâche, W. Fischer, R. Siegwart, R. Moser, and F. Mondada, "Compact magnetic wheeled robot with high mobility for inspecting complex shaped pipe structures," in *Intelligent Robots and Systems, 2007. IROS 2007. IEEE/RSJ International Conference on*. IEEE, 2007, pp. 261–266.
- [29] M. Eich and T. Voegelé, "Design and control of a lightweight magnetic climbing robot for vessel inspection," in *Control & Automation (MED), 2011 19th Mediterranean Conference on*. IEEE, 2011, pp. 1200–1205.
- [30] W. Shen, J. Gu, and Y. Shen, "Proposed wall climbing robot with permanent magnetic tracks for inspecting oil tanks," in *IEEE International Conference On Mechatronics and Automation*, vol. 4. IEEE, 2005, pp. 2072–2077.
- [31] L. P. Kalra, J. Guf, and M. Meng, "A wall climbing robot for oil tank inspection," in *ROBIO'06. IEEE International Conference on Robotics and Biomimetics*. IEEE, 2006, pp. 1523–1528.
- [32] D. Schmidt, C. Hillenbrand, and K. Berns, "Omnidirectional locomotion and traction control of the wheel-driven, wall-climbing robot, cromsci," *Robotica*, vol. 29, no. 7, pp. 991–1003, 2011.
- [33] A. Oliveira, M. Silva, and R. Barbosa, "Architecture of an wheeled climbing robot with dynamic adjustment of the adhesion system," in *8th International Symposium on Intelligent Systems and Informatics (SISY)*. IEEE, 2010, pp. 127–132.
- [34] M. Tavakoli, L. Marques, and A. de Almeida, "Omnidirectional light weight climbing robot with flexibility to adapt to non-flat surfaces," in *IEEE/RSJ International Conference on Intelligent Robots and Systems, IROS, Vilamoura-Portugal*, 2012.
- [35] P. magnet distributor, "http://www.hkcm.de," Web reference, Jan 2012.
- [36] *CRC Handbook of Physical Quantities*. Boca Raton, FL: CRC Press, 1997.
- [37] Robotis Co., "http://www.robotis.com," Web reference, Jan 2012.

Mahmoud Tavakoli Received his PhD in Automation and Instrumentation from University of Coimbra, Portugal in 2010, and his MSc in Mechanical Engineering from Sharif University of Technology, Iran. Currently he is a Post-Doc researcher in ISR-UC. His research interests include field and service robots, inspection robots and climbing robots. He is the author of more than 20 publications as books, book chapters, and articles in international peer reviewed journals and conferences.

Carlos Viegas is a researcher in Institute of Systems and Robotics, at Coimbra. He is currently concluding his Master's Degree in Mechanical Engineering in University of Coimbra. His work and research are focused primarily on conceptual and mechanical design of mobile robots.

ACCEPTED MANUSCRIPT

Lino Marques has a Ph.D. degree in Electrical Engineering from the University of Coimbra, Portugal. He is currently a Senior Lecturer at the Department of Electrical and Computer Engineering, University of Coimbra, and he heads the Embedded Systems Laboratory of the Institute for Systems and Robotics from that university (ISR-UC). His main research interests include embedded systems, mechatronics, robotics for risky environment.

J. Norberto Pires is Associate Professor of the Mechanical Eng. Dep. of the University of Coimbra. His research interests include force control, industrial robotics, object-oriented and distributed programming applied to industrial robotics, flexible manufacturing systems and human-machine interfaces. He is the author of 3 books in the robotics and automation areas and more than 100 scientific/technical publications.

ACCEPTED MANUSCRIPT

Aníbal T. de Almeida is Full Professor of the Electrical Engineering Department of University of Coimbra and Director of the Institute for Systems and Robotics (ISR)-Coimbra. He has participated in several research projects and is author of more than 200 research articles. He was the General Chair of several conference including ROS-2012 in Portugal.

Mahmoud.png

SCRIPT



Carlos.png

SCRIPT



Lino.png

SCRIPT





SCRIPT

Anibal.jpg



HIGHLIGHTS

- Omniclimbers are agile robots for climbing and navigation over ferromagnetic structures.
- They are specially designed to rapidly reach any required pose on the structure.
- They use omnidirectional wheels for a good maneuverability.
- The novel central magnet grant the required normal force while keeping the friction low.
- They adapt passively to various structure material, diameter and thicknesses.

OmniClimbers are light weight climbing robots with flexibility to adapt to non-flat surfaces. OmniClimbers are being developed at Institute for Systems and Robotics of the University of Coimbra, Portugal.

The video demonstrates several experiments which was performed by 2 versions of the robot OmniClimberI and II. The first experiment is on a locker in laboratory and the second experiment is performed on a propane gass bottle and the third experiment is on a curved horizontal structure. Ombiclimbers can navigate on both structure with a good maneuverability.