



23rd International Conference on Material Forming (ESAFORM 2020)

Comparative Analysis of Different Cutting Milling Strategies Applied in Duplex Stainless Steel

Paulo Amaro^a, Pedro Ferreira^{a, b, *}, Fernando Simões^{a, b, c}

^a Polytechnic Institute of Coimbra - Coimbra Institute of Engineering, DEM, 3030-199 Coimbra, Portugal

^b IIA - Institute of Applied Research - Polytechnic Institute of Coimbra, 3030-199 Coimbra, Portugal

^c CEMMPRE - Center for Mechanical Engineering, Materials and Processes - University of Coimbra, Portugal

* Corresponding author. Tel.: +351 239 790 200; fax: +351 239 790 201. E-mail address: pmsf@isec.pt

Abstract

It is well known that the duplex stainless steels are considered to be difficult-to-machine because of its high toughness, low thermal conductivity, and high degree of work hardening. When machining this type of materials, the tools presents an irregular wear and often occur a built-up edge (BLUE) [1]. This work studies the influence of cutting milling strategy in the machinability of these alloys, comparing conventional and trochoidal toolpaths, milled with a tool that have interchangeable inserts coated with AlTiN. Concerning to the cutting parameters, the values recommended by the tool manufacturer (90-120 m/min.) were applied to the conventional milling strategy, while for the trochoidal milling strategy were applied higher cutting speeds, in a range of 120 to 300 m/min. For both strategies, the results shown that the tool edge damage is characterized by a progressive development of a flank wear, followed by chipping phenomenon, that usually first appear localized in the region of the cutting edge where the contact with the chip ends. As the machining continues, a non-uniform chipping appears along the cutting edge. For the conventional milling strategy, the best results were obtained for the cutting speed of 120 m/min, with a material removal rate of 17,16 cm³/min. and a tool life of 20 minutes. For the trochoidal strategy, it is possible to double the cutting speed (240 m/min), maintaining the same tool life time (20 min.), and increasing the material removal rate up to 23,66 cm³/min.

© 2020 The Authors. Published by Elsevier Ltd.

This is an open access article under the CC BY-NC-ND license (<https://creativecommons.org/licenses/by-nc-nd/4.0/>) Peer-review under responsibility of the scientific committee of the 23rd International Conference on Material Forming.

Keywords: Duplex Stainless Steels; Conventional and Trochoidal Milling; Tool Life; Material Removal Rate; Tool Wear

1. Introduction

Stainless steels are ferrous alloys which have in their chemical composition a minimum content of chromium between 10% and 12%. Chromium is considered to be the most important alloying element because it gives stainless steels high resistance to corrosion, and the higher their content, the higher their strength. There is a wide variety of stainless steels with progressively higher levels of corrosion resistance and mechanical strength. This differentiation is caused by the controlled addition of alloying elements, where each of these elements gives rise to specific properties in the stainless steel.

Nomenclature

a_e	axial cut
a_p	depth cut
D_c	cutting diameter
D_m	groove width
D_{vf}	diameter of tool center travel
f_z	feed per tooth
n	rotation of the tool
VB_1	flank wear
VB_3	notch wear
V_c	cutting speed
V_f	tool center feed
V_{fm}	periphery feed of the tool

2351-9789 © 2020 The Authors. Published by Elsevier Ltd.

This is an open access article under the CC BY-NC-ND license (<https://creativecommons.org/licenses/by-nc-nd/4.0/>) Peer-review under responsibility of the scientific committee of the 23rd International Conference on Material Forming.

10.1016/j.promfg.2020.04.132

Z_n	number of flutes of the tool
w	stepover

Stainless steels is usually divided into five types: ferritic, austenitic, Martensitic, duplex and precipitation hardening (PH). The machinability of a metal is a technological quantity, which expresses by means of a comparative numerical value (machinability index) a set of machining properties of a steel, relative to another steel taken as the standard. This can be measured through various indicators such as tool life, chip volume removed per unit of time, strength and power required for material cutting, work surface finish or cutting temperature. The steel used as the standard is AISI 1212, which has a machinability index of 100%. If the index of machinability of a work material is less than 100%, then that material is more difficult to machine than AISI 1212 steel [1].

When comparing the index of machinability between the different types of stainless steels, can refer that austenitic and some martensitic steels have low machinability due high tensile strength, high ductility and toughness, a high work hardening rate and low thermal conductivity [2,3]. High machinability, is attributed to the ferritic stainless steels, because that machinability rating is about 90% when comparing to the AISI 1212 steel. Duplex stainless steels are considered to be difficult-to-machine because of its high toughness, low thermal conductivity and high degree of work hardening. On the other hand, irregular wear and a built-up edge (BUE) often occur in machining operations [1].

This work studies the influence of cutting milling strategy in the machinability of duplex stainless steels, comparing conventional and trochoidal toolpaths. Regarding to the conventional toolpath, the strategy applied was a face milling toolpath with dynamic motion. With the relative motion between the cutter teeth and the workpiece, a face milling cutter leaves feed marks on the machined surface similar to those left by turning operations [4]. This type of strategy is based on what we can call machining by "Offsets", that is, the cutting movements are defined parallel to the geometry of the part, (Fig. 1).

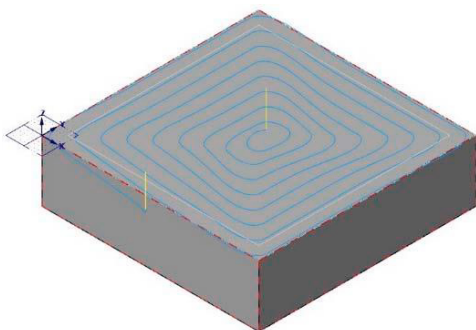
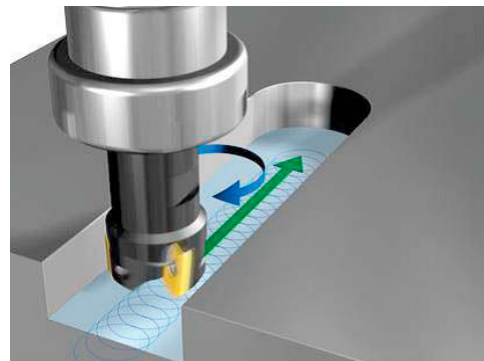

Fig. 1. Conventional toolpath trajectory with parallel "Offsets".

Although trajectories parallel to the contour are the best option to reduce the operating times, in most situations, because presenting a simple concept and fast to calculate by the computer, it presents a problem that becomes more evident in

the machining of materials of high hardness and in high speed milling. This problem is related to the significant variation of the contact arc of the milling cutter and to the feed speed, particularly in corners and in segments with a change of direction with a small radius of curvature. On the other hand, the cutting parameters are poorly optimized and depend on the geometry of the part. Concerning to the trochoidal milling, the strategy of tool movement can be defined as circular milling that includes simultaneous forward movements. The cutter removes repeated slices of material in a sequence of continuous spiral toolpaths in its radial direction (Fig. 2).



(a)

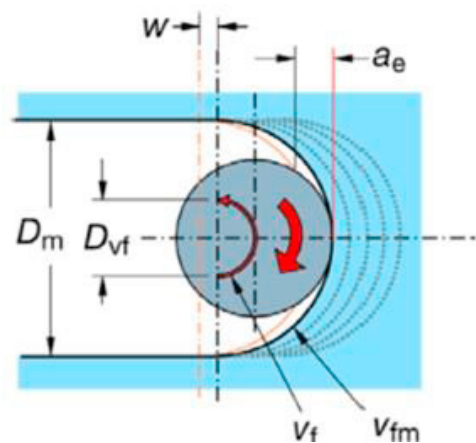

(b)

Fig. 2. Movement of the tool during trochoidal toolpath (a), parameters involved in trochoidal milling (b) [5].

The entire length of the cutting edge could be used, once it is possible use an axial cut (a_p) up to twice the tool diameter. The heat and the wear is distributed throughout the cutting edge, providing a longer tool life than in traditional milling [6]. In addition, the reduced contact time between the cutting edge and the material, provides a less heat transferred, benefiting the tool life, the productivity and the tolerance of the parts. Trochoidal milling is an excellent method for slotting when vibration is a problem, for rough milling of confined cavities, pockets and grooves, once reduce the radial engagement. Despite it requires specialized computer aided manufacturing (CAM)

programming and machine tool capabilities, the advantages of this type of strategy appear to be very promising to apply in duplex stainless steel [7,8].

Understanding the parameters involved in the trochoidal toolpath is more complex than in the conventional toolpath. The traditional formula to calculate the tool feed (1) is related with the periphery feed (v_{fm}) of the tool in trochoidal toolpath. The feed of tool center (v_f) is in this case different of periphery feed and can be calculated by the formula (2) and (3) [5].

$$v_{fm} = n \times f_z \times z_n \quad (1)$$

$$D_{vf} = D_m - D_c \quad (2)$$

$$v_f = \frac{D_{vf}}{D_m} \times v_{fm} \quad (3)$$

2. METHODOLOGY

The workpiece material used in the milling test was an duplex stainless steel GX6CrNiN26-7 with the dimensions of 300 mm × 300 mm × 85 mm (length x width x height) and a CNC milling machine was used. The cutting tool used in the experimental work was an end mill tool with three interchangeable insert and weldon type shank, manufactured by Palbit®. The tool has an insert positioning angle of 90 degrees, a cutting diameter (D_c) of 32 mm, and a maximum depth cut of 9 mm. The interchangeable inserts used are made in tungsten carbide coated with AlTiN, manufactured and classified by the Palbit® in grade coding system by PH7930 (equivalent to the M30 ISO designation). Conventional and trochoidal toolpaths were generated using the computer aided manufacturing Mastercam software. For conventional milling toolpaths a depth cut (a_p) of 2,5 mm was defined for experimental tests. The axial cut (a_e), the feed per tooth (f_z) and the cutting speed applied, are indicated in table 1.

Table 1. Cutting parameters defined for conventional milling tests.

	V_c [m/min.]	a_p [mm]	$a_e = 60\% D_c$ [mm]	f_z [mm/tooth]
Test 1	90	2,5	19,2	0,1
Test 2	120	2,5	19,2	0,1

Regarding to the trochoidal toolpath, a depth cut (a_p) of 7,5 mm was defined for experimental tests. The axial cut (a_e), the feed per tooth (f_z) and the cutting speed applied, are indicated in table 2.

Table 2. Cutting parameters defined for trochoidal milling tests.

	V_c [m/min.]	a_p [mm]	a_e [mm]	f_z [mm/tooth]
Test 3	120	7,5	5,21	0,15
Test 4	240	7,5	5,21	0,15
Test 5	240	7,5	5,21	0,20
Test 6	300	7,5	3,89	0,15

Concerning to the cutting speed (V_c), in test 3 was defined a value according with the recommendations of tool manufacturer for conventional milling toolpaths ($V_c=120$ m/min.). In test 4 and 5, a cutting speed of 240 m/min. was defined. In test 6, a very high value of cutting speed was used ($V_c=300$ m/min.), in order to evaluate the tool behavior on severe cutting conditions. To determine the end of life of the cutting tools, flank wear ($VB_1=0,35$) and notch wear ($VB_3=1,00$) values established by ISO 8688-1 standard was considered.

3. RESULTS AND DISCUSSIONS

Analyzing the edges of the tool, it's possible to conclude that the main damage is located on the peripheral edges, while the bottom edges doesn't show significant change. For both strategies (except for test 6, where due to severe cutting conditions, the tool life has a significant decrease), the results shown that after 5 min., the tool edge damage is characterized by a progressive development of a flank wear in the entire length of the active cutting edge, as be seen for conventional in Fig. 3 and for trochoidal milling in Fig. 4.

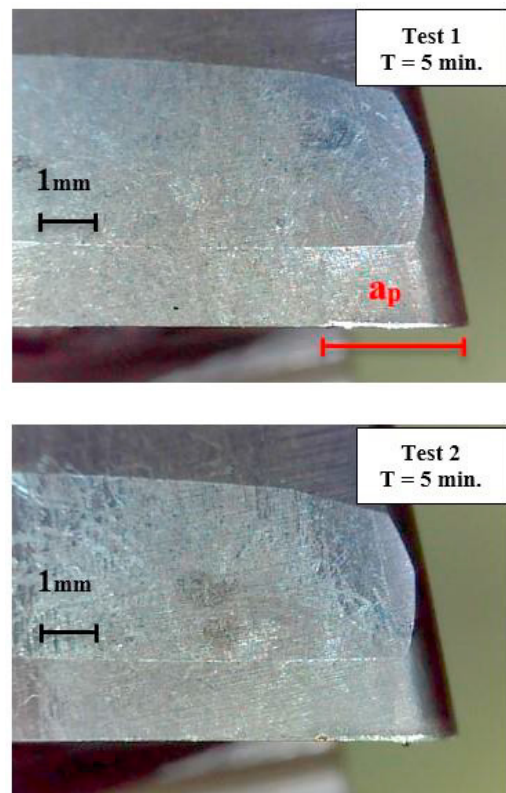
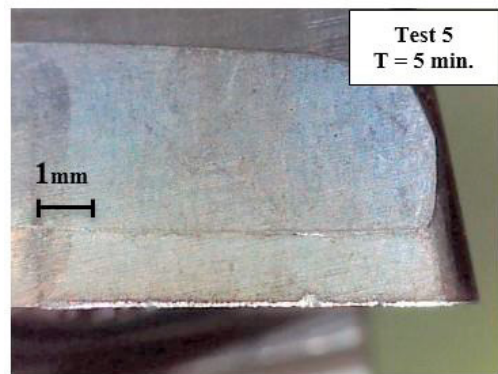
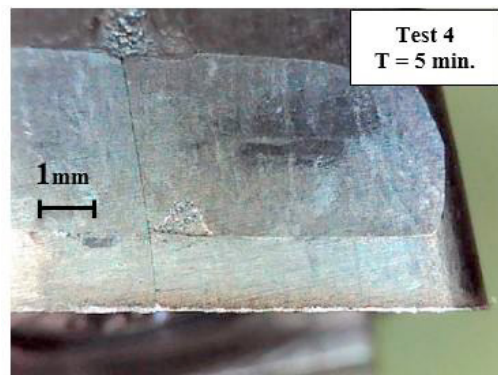
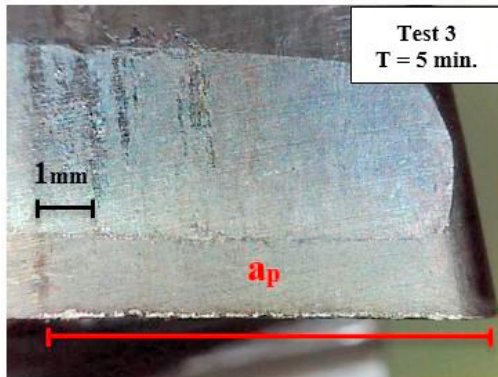

Fig. 3. Uniform flank wear of the tool after 5 min. milling for conventional tests.



As the machining continues, additionally to flank wear, it is also possible to identify a cyclic process of localized adhesion of the chip to the cutting edge, followed by chipping with loss of the coating and substrate exposure. The chipping phenomenon is not uniform, and usually first appear localized in the region of the cutting edge where the contact with the chip ends. In this region of the cutting edge, occurs a transition of compressive to tensile stress and, as consequence, the chipping is facilitated as be seen in Fig. 5 and Fig. 6.

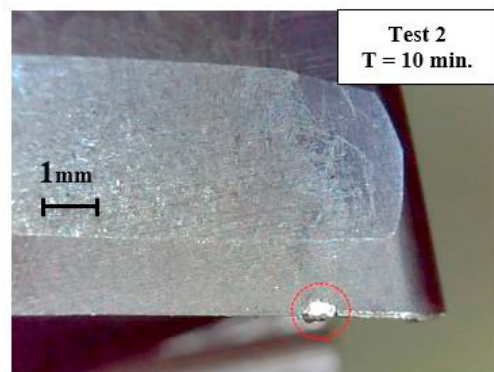
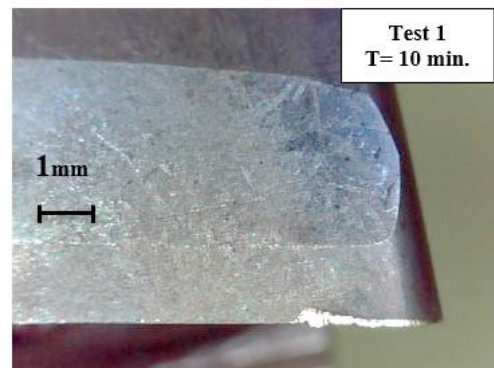

Fig. 4. Uniform flank wear of the tool after 5 min. milling for trochoidal tests.

Fig. 5. Localized chipping of the tool for conventional milling tests.

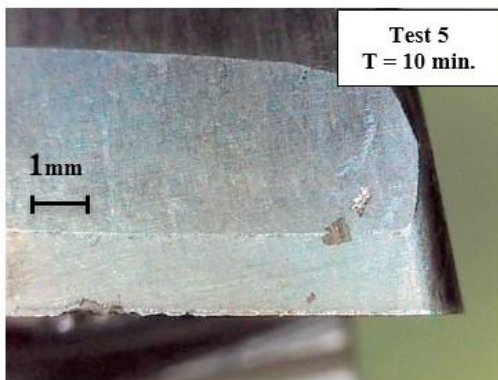
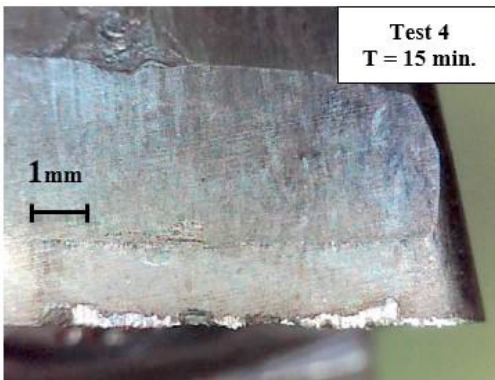
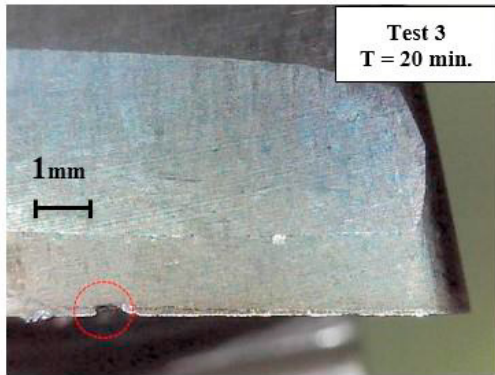

Fig. 6. Localized chipping of the tool for trochoidal milling tests.

After some time, a non-uniform chipping arises, sometimes an exaggerated localized chipping appears and the tool becomes more vulnerable, noting the existence of a non-uniform flank wear up to the end of tool life (Fig. 7 and Fig. 8).

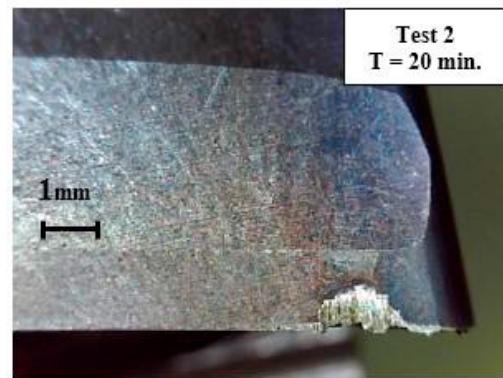
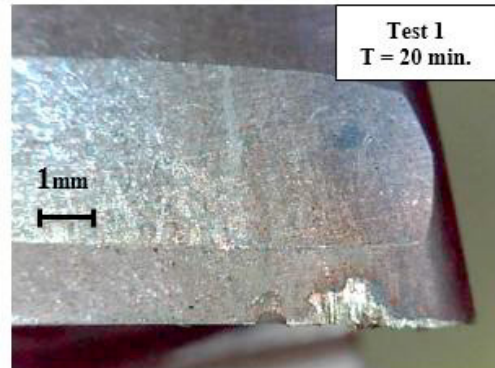

Fig. 7. Chipping and non-uniform flank wear of the tool for conventional milling tests.

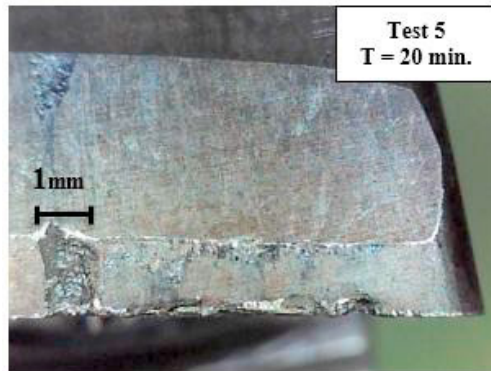
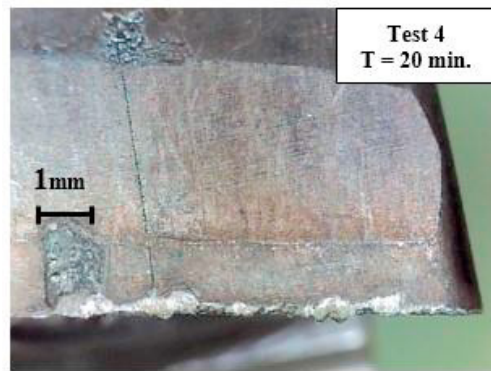
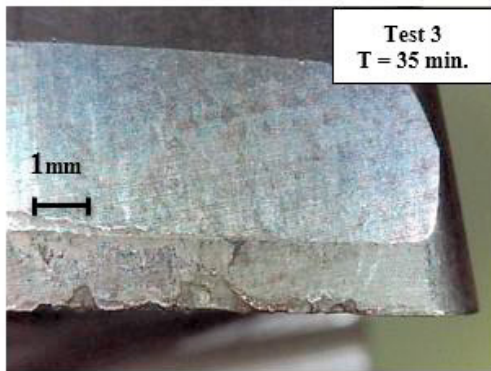

Fig. 8. Chipping and non-uniform flank wear of the tool for trochoidal milling tests.

In Table 3 and Table 4 are presented the material removal rate and the tool life for each experimental test. Analyzing the conventional milling test it is possible to verify that the increased of the cutting speed doesn't affect the tool life and is benefited, once the material removal rate increased approximately 35% for test 2.

Table 3. Material Removal rate and tool life time for conventional milling tests.

	V_c [m/min.]	f_z [mm/tooth]	Material removal rate [cm ³ /min]	Tool life time [min.]
Test 1	90	0,1	12,91	20
Test 2	120	0,1	17,16	20

Table 4. Material Removal rate and tool life time for trochoidal milling tests.

	V_c [m/min.]	f_z [mm/tooth]	Material removal rate [cm ³ /min]	Tool life time [min.]
Test 3	120	0,15	8,87	35
Test 4	240	0,15	17,75	20
Test 5	240	0,20	23,66	20
Test 6	300	0,15	15,74	5

When comparing tests 2 and 3, where the cutting speed was the same, changing the type of machining strategy, it is possible to verify that the tool life is approximately 75% higher (35 min.) in the trochoidal milling than in the conventional milling. However, the material removal rate decreases from 17,16 to 8,87 cm³/min.

Regarding to the trochoidal milling tests 4 and 5, it's observed that this cutting speed increase correspond to the tool life decreases from 35 min. for 20 min. This reduction in tool life is approximately 40%. However, the material removal rate increase significantly, especially when the feed per tooth is 0,20. When the cutting speed reaches 300 m/min., the degradation of the tool is much more sharp, and the life is only 5 min (Fig. 9).

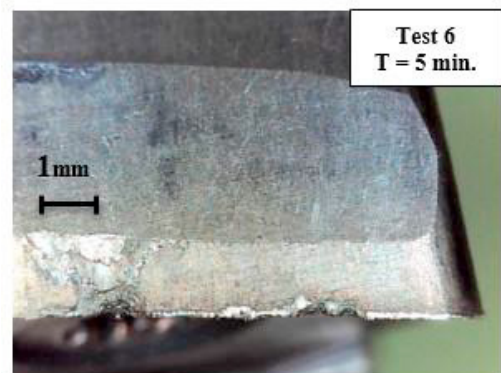
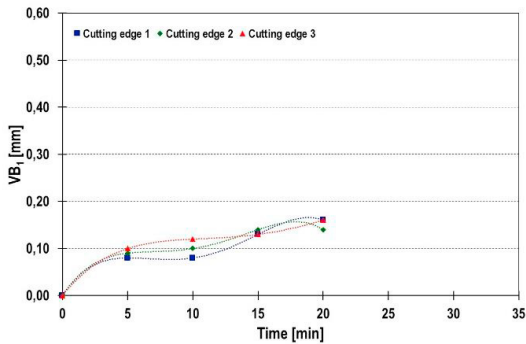
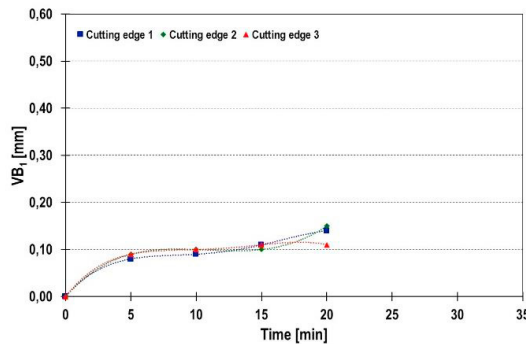

Fig. 9. Tool life for $V_c=300$ m/min. in trochoidal milling (5 min.).

Fig. 10 shows the evolution of tool wear for each test performed.



(a)



(b)

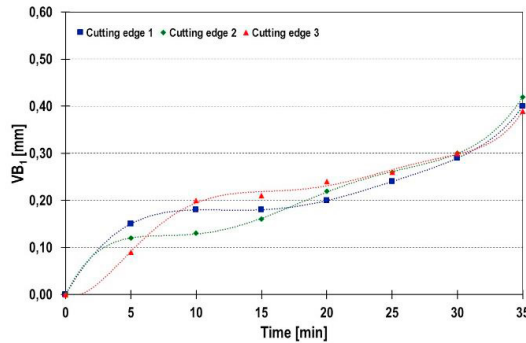

(c)

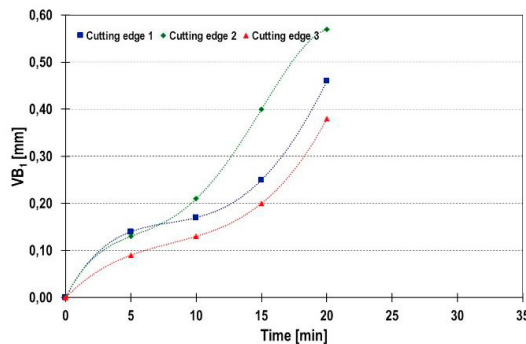

(d)

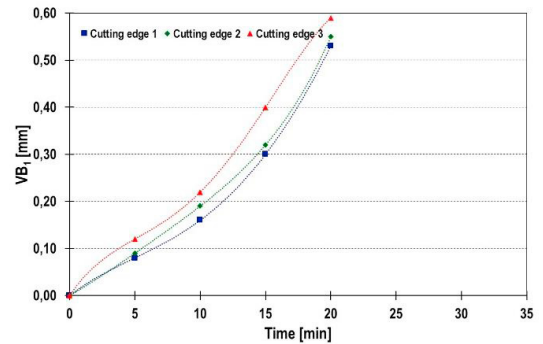

(e)

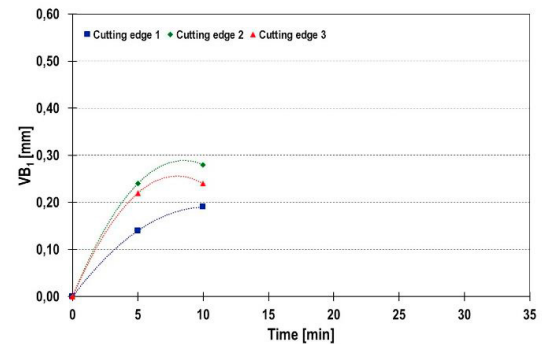

(f)

Fig. 10. Evolution of uniform wear for each cutting edge of the tool, during conventional and trochoidal milling: test 1 (a), test 2 (b), test 3 (c), test 4 (d), test 5 (e) and test 6 (f).

Analyzing the results, it's possible to conclude that Fig. 10(a) to 10(e) shown flank wear evolution curves similar those described in literature. The wear grows rapidly at the beginning of milling, passing to a second stage where that wear increases gradually and predictably, entering at the end of tool life in the third stage, where the wear rapidly increases in a short time. For test 6 this wear evolution was not verified due to the aggressive test parameters.

4. CONCLUSION

For the conventional milling strategy, the best results were obtained for the cutting speed of 120 m/min, with a material removal rate of 17,16 cm³/min. and a tool life of 20 minutes. Trochoidal strategy has productivity advantages, once it is possible to double the cutting speed applied in conventional milling (240 m/min), keeping the same tool life time (20 min.) and increasing the material removal rate up to 23,66 cm³/min. The extended tool life for trochoidal milling is possible, once the wear is distributed throughout the cutting edge and the reduced contact time between the cutting edge and the material, provides a less heat transferred, benefiting the tool life.

Acknowledgements

The authors are thankful to Palbit - Hardmetal Tools Solutions, for providing tools and test material.

References

- [1] Paro P, Hanninen H, Kauppinen K. Tool wear and machinability of HIPed P/M and conventional cast duplex stainless steels. *Wear* 2001;249:279–84.
- [2] Ingle V, Patil A, Patel R. Machining Challenges in Stainless Steel – A Review. *International Journal of Advance Research, Ideas and Innovations in Technology* 2017;3-6:1395-402.
- [3] Kaladhar M, Subbaiah K, Rao C. Machining of austenitic stainless steels - A review. *Int. J. Machining and Machinability of Materials* 2012;12(1/2): 178-92.
- [4] Hadad M, Ramezani M. Modeling and analysis of a novel approach in machining and structuring of flat surfaces using face milling process. *International Journal of Machine Tools & Manufacture* 2016;105:32–44.
- [5] Sandvik. *Manual técnico*. Suécia: Elanders; 2010.
- [6] Waszczuk K, Karolczak P, Wiśniewska M, Kowalski M. Influence of the path type on selected technological effects in the trochoidal milling. *Adv. in Science and Technology Research Journal* 2107;11(1):147–53.
- [7] Pleta A, Niaki F, Mears L. Investigation of chip thickness and force modelling of trochoidal Milling. *Procedia Manufacturing* 2017;10:612–21.
- [8] Amaro P, Ferreira P, Simões F. Tool wear analysis during duplex stainless steel trochoidal milling. *Proceedings of the 21st International ESAFORM Conference on Material Forming* 2018;070001-1 - 070001-6.